



Billi®



home
collection
2025

Superior Instant Filtered Water



BOILING



CHILLED



SPARKLING



STILL

Designed and manufactured in  Australia to the highest quality standards

CONTENTS

04 | Welcome to Billi Home

04 | Product features

06 | Billi's sustainability commitments

07 | Our process

08 | Premium filtration

09 | Service plans

10 | Product summary

11 | Billi 3D Build

12 | All new products
- Multifunction Mixer Tap
- Billi Home BCS

14 | Product range

- Billi Home BC
- Billi Home BA
- Billi Home C
- Billi Home CS
- Billi Home FT
- Billi B5000 Sparkling

20 | Finishes

22 | Tapware

- X-Series dispensers
- Slimline dispensers
- Multifunction & Mixer Taps

25 | Accessories

26 | Why customers love their Billi



Welcome to



Originating in Australia, Billi has been at the forefront of the instant filtered boiling and chilled water systems industry for over 30 years. Billi products are celebrated for their combination of functionality, performance and contemporary aesthetics. Proudly Australian-made and designed,

Billi products have brought a unique concept of underbench instant filtered boiling, chilled and sparkling drinking water to many countries around the globe.

Manufactured in Melbourne, Australia to strict quality standards, Billi water systems come with an assurance of quality, innovation and sustainability.

Incorporating cutting edge eco-technology features and modern designs, Billi delivers solutions that keep pace with the ever-changing needs of its users.



Billi

 **PRODUCT FEATURES**



All Billi Home systems are designed and manufactured in Australia.



With a focus on space saving, Billi systems continue to offer the smallest footprints on the market, allowing you to make the most of the valuable underbench space.



Billi's unique Heat Exchange Technology enables our systems to achieve substantial energy savings. Our units also feature a standby mode which conserves energy by powering down after 2 hours of non-use.



Billi's X series dispensers are supplied standard with a safety switch to lock off access to boiling water where needed. The red lock icon demonstrates when the safety switch is activated. Simply touch the sensor switch to release the lock and activate the boiling water. The dispenser will revert to safety mode after a period of non use.



The Billi Billi Home BC and BA systems incorporate Eco-Intelligence technology which is a self learning timer allowing the unit to only operate when required. The self learning timer monitors daily usage patterns and even recognises evening and weekend changes in routine to effectively minimise energy consumption.



Our Ice bank technology has a chilled reservoir where both sparkling and chilled water supply passes through. In doing so, the dispensed water temperature is consistently chilled, also providing a higher level of carbonation.



Billi's Sparkling water just tastes better! Whether it be the superior Water Cooled technology of our new Billi Home BCS or the Ice Bank technology of our B5000 Sparkling solution, you can rest assured that you're enjoying the freshest instantaneous Sparkling water on the market.



A simple adjustable control knob allows the chilled water temperature to be raised to 15°C or lowered to 6°C for perfectly chilled, refreshing drinks. Your desired temperature is reached quickly and maintained efficiently during operation.



Adjust the level of sparkling to suit your taste, with adjustable controls up to 5 bar of CO₂ pressure.



The Billi Home BCS, C, BA, BC and FT range all offer a continuous supply of filtered water even when tank supplies are exhausted.*



The Billi Home range offers a variety of dispenser options including our Multifunction Mixer, X series and slimline dispensers in a selection of modern finishes. Site specific tapware is available, including an XL Levered dispenser with red & blue coloured levers and braille pads for vision impaired applications.



Match the finish and styling of your Billi dispenser with our Standalone Mixer Taps.



Billi has a range of stylish and functional accessories to match your needs including fonts, risers and tubing extension kits.



Billi's highly experienced professional service technicians can manage the installation of your Billi Unit. Service plans and filter subscriptions are also available to ensure you never have to worry about the maintenance of your unit.



The health & hygiene of your drinking water is of utmost importance. Billi's suite of Hygiene Protection Protocols include a digital lockout and visual reminder in the dispenser to ensure your filter is changed at appropriate frequencies and can only ever be used once.



Billi now offers customers an environmentally friendly option to rent CO₂ & Regulator packages, with a periodic refill service provided to site.

*Safety time out features and the required filter changes for hygiene still apply.



Matte White XL Dispenser with matching 70mm riser and font 5

Unlocking a sustainable future begins with a shared commitment to the United Nations Sustainable Development Goals (SDGs) – a profound set of 17 interconnected objectives designed as a global benchmark. These goals intricately address the multifaceted challenges our world faces, setting the stage for a harmonious coexistence between people and the planet.

At Billi, we wholeheartedly embrace this global initiative by aligning our mission and practices with the UN SDGs. Our pledge is more than a commitment; it's a proactive step towards contributing to the worldwide endeavour for a more equitable, sustainable, and inclusive world.

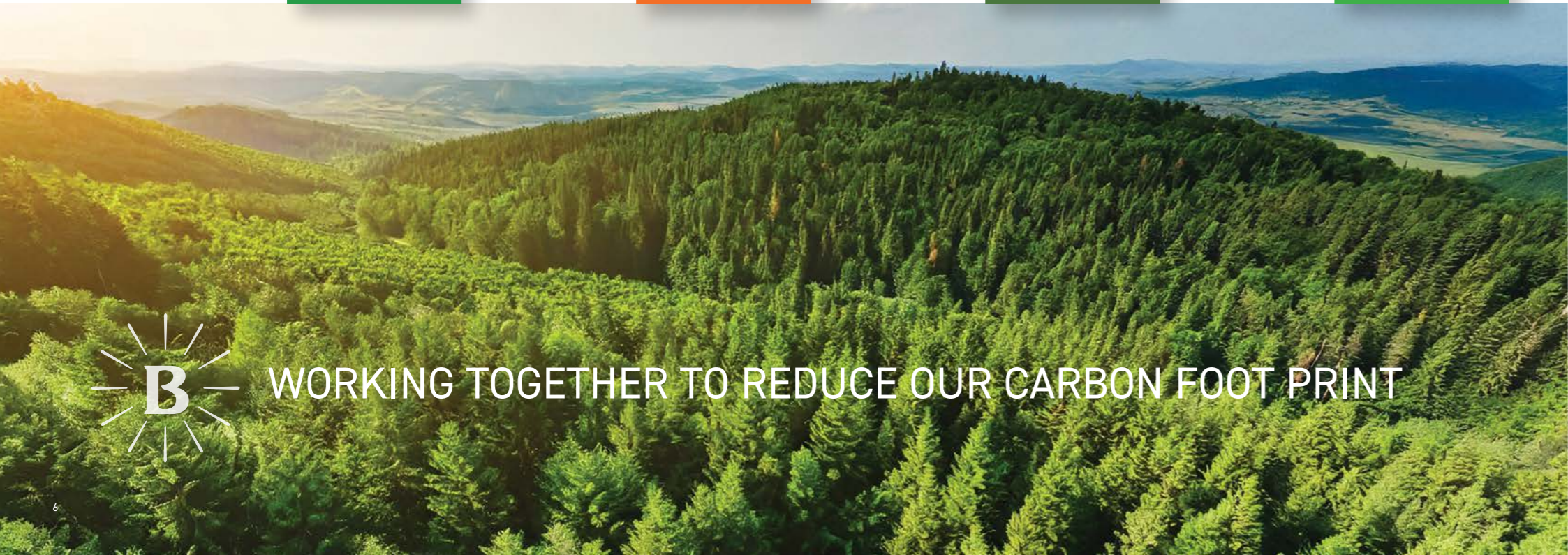

WORKING TOGETHER TO REDUCE OUR CARBON FOOT PRINT

At Billi, sustainability and innovation stand as cornerstone principles within our operational framework. Our steadfast commitment to integrating sustainability across all aspects of our business model is evident from the outset.

From the meticulous sourcing of raw materials to the thoughtful design of sustainable solutions, concluding with our rigorous recycling practices for both packaging and products, every step reflects our dedication to environmental stewardship.

SUSTAINABILITY IMPACT

We recognise that a sustainable future requires an ongoing evolution of our approach, a commitment to constant improvement, and a steadfast dedication to understanding and mitigating our impact. Our sustainability journey transcends the traditional boundaries, reaching beyond the realms of manufacturing and product usage.

REDUCING CARBON FOOTPRINT

Billi proudly stands as a testament to sustainability, having undergone rigorous assessment and certification through Global GreenTag's LCARate™ program. Our commitment to environmental responsibility is reflected in our range of water-cooled products. Certified by Global GreenTag, our water-cooled products boast a lower carbon footprint that is known & measurable.

WASTE REDUCTION

We recognise the urgent need to minimise all forms of waste, and to fulfill this commitment, we have forged strategic partnerships within the industry. These collaborations are designed to ensure the recyclability and re-use of materials wherever possible. In our pursuit of waste reduction, we have introduced pioneering packaging solutions and incorporated recycled materials, such as tank insulation.

WATER-COOLED or AIR-COOLED TECHNOLOGY

Billi are the only manufacturer to offer both water-cooled and air-cooled options. Our water-cooled systems utilise heat exchange & energy reclaim technologies and are more energy efficient than our air-cooled systems. Billi's heat exchange technology ensures water usage is minimal. Billi's air-cooled options generate far less heat than traditional air-cooled systems.

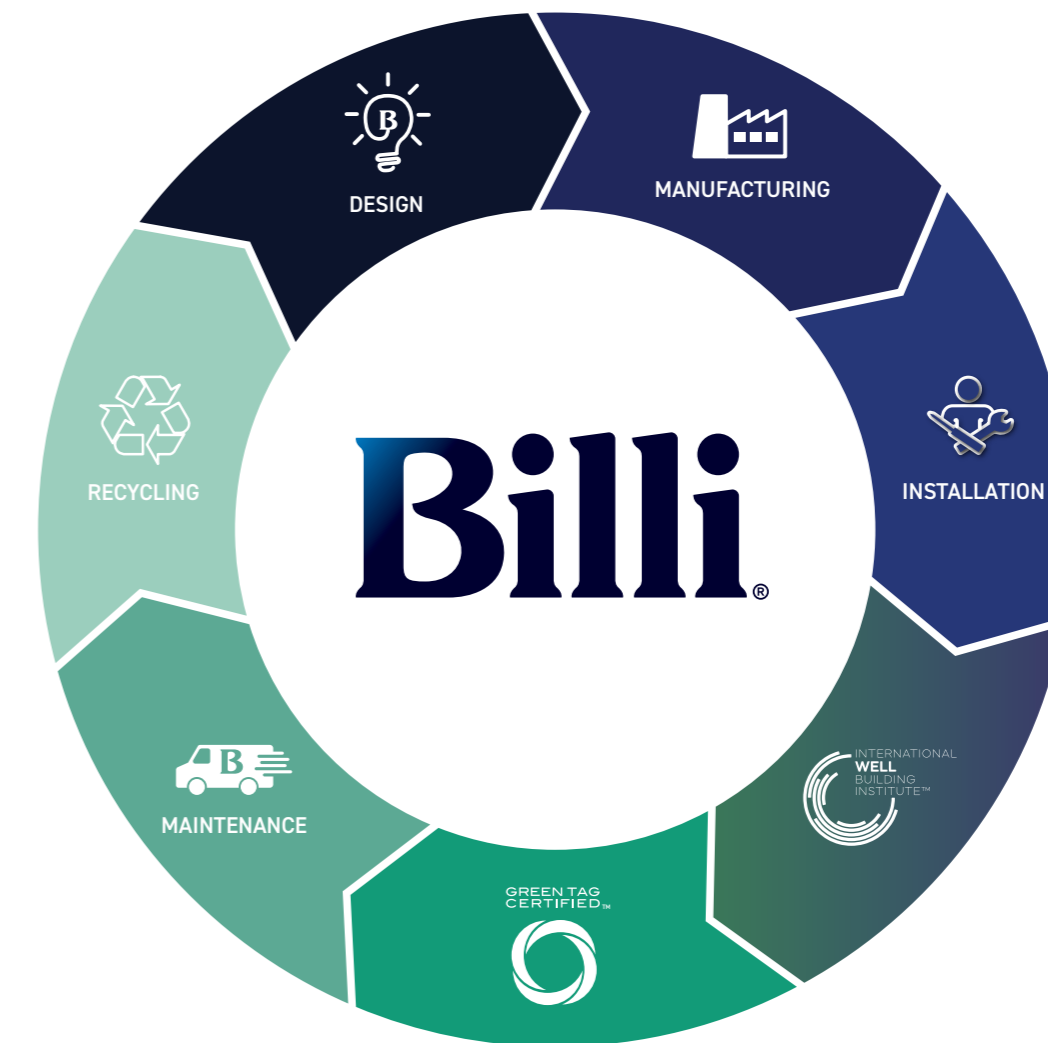

ENERGY SAVING

Billi's range of water-cooled products stands out for its innovative approach to sustainability. Our products possess the unique capability of converting waste heat into a valuable source of heating energy. By harnessing waste heat and turning it into a usable energy source, our water-cooled products exemplify a commitment to resourcefulness and environmental responsibility.

EMPOWERMENT & GOOD GOVERNANCE

Our employees are essential contributors to the realisation of our sustainability goals. Our commitment goes beyond products and processes – it extends to fostering a workplace culture that values and empowers our team members. Billi provides a supportive environment where our employees are not only encouraged but also empowered to embrace and promote sustainable practices in both their professional and personal lives.

CERTIFICATION

Unwavering commitment to surpassing the standards of being just fit for purpose. Billi has successfully achieved certifications that not only validate our products' performance but also highlight our contributions to broader sustainability goals. Our dedication to environmental responsibility is underscored with continued measurement & recognition from product certifications such as 'Global Greentag' and 'Works with WELL,' and the augmentation of our Management Systems, adding Environmental Management System (EMS) ISO 14001 and Occupational Health and Safety System (OHSMS) ISO 45001, to our existing Quality Management System (QMS), ISO 9001.

WELLBEING

Enhancing the wellbeing of end-users is ingrained in our DNA. We are Cornerstone Members of the International Well Building Institute, and are product certified by the Works with WELL program, a testament to our dedication to setting new standards in creating environments that prioritise health and wellbeing.

Replacement Filters

Periodic replacement of filters is necessary to maintain water quality and ensure optimal health benefits. Genuine replacement Billi filters are available through our website and locally from your approved supplier. Filters MUST be replaced every 12 months as a minimum, in some areas or with high usage it is recommended this is increased to a frequency of 6 months.

All Billi genuine filters are in built with our Hygiene Protection Protocols. These includes a digital lockout feature preventing risk of expired consumables being re-used or prolonged exposure to pathogens to ensure the safety and optimal performance of your system. They also have a visual change reminder alarm built into the dispenser display where amber lights will flash repeatedly to indicate it's time to change your filter.

Filtration capabilities

Billi Filters have the following filtration capabilities:



SEDIMENT
Filters out particles in the water



CHEMICALS
Reduces Chlorine and organic chemicals



MINERALS
Enables minerals to flow through the appliance without allowing scale build up



CYSTS
Removes parasitic cysts giardia and cryptosporidium (994052 & 994060 only)



LEAD
Reduces Lead and heavy metals (994052 only*)

Billi filters have been independently tested and certified by IAPMO to international standards and Australian Watermark. Billi filter performance testing is conducted in accordance with international standards NSF, WRAS and Watermark. *Lead Reduction on 994052 @ 98.93%

Our leading replacement filter

Billi's 0.2 Micron Fibron XC replacement filter has the capability of filtering Sediment, Chlorine, Paracitic Cysts, and Lead. It leaves you with odourless, great tasting water every time. This is the most appropriate filter for residential customers.

Changing filters

To change your own filter please refer to the link provided below, but for true peace of mind and regular maintenance of your system by an expert, why not consider one of our Service Plan offerings overleaf such as a 4 year Service Certificate or a Silver Filter plan?

Visit: www.billi.com.au/billi-how-to-videos





0.2 Micron Fibron XC® Replacement Filter 994052

Normal Filter Rating	0.2 Micron
Filtration Capability	Sediment, Chlorine, Taste & Odour, Paracitic Cysts, Lead
Flow Rate	3.8lpm
Water Pressure	80 kPa min - 860 kPa max
Capacity	30,000 litres (Chlorine reduction)
Water Temperature	38°C max. Must not freeze

Billi offers the very best in innovation, superior performance and reliability and we back this up with a world class customer service experience ethos. Instant filtered drinking water systems do require service & maintenance and filter replacements to ensure optimal water quality and health benefits.

Billi's service model includes an Australia-Wide network of trained technicians and service agents being backed up by a technical support team at the point of production. Their expertise and service is technically correct, prompt, reliable and available.

Our commitment is to make that easy for you starting with installation and then looking after you for the life of your product.

For more information on our service plans, please visit our website www.billi.com.au/billicare-service-plans



Billi Installation

A Billi accredited technician can offer Standard Installation in residential premises. Standard Installation Requirements regarding water and power supply must be met and does not include any cutting of manufactured stone, granite or natural stone bench tops or bench tops that are more than 48mm thick.



4 Year Service Certificate

All new units are eligible for access to our 'peace of mind plan', that provides 4 years of filter changes and comprehensive service for a fixed annual fee. The Service certificate can be purchased strictly for a period of 60 days from delivery.



Silver Service Plan

Filter replacement plan, performed by a Billi accredited technician. Fixed rate for the duration of your agreement.







Refillable CO2 Filter Plan

Billi now offers customers an environmentally friendly option to rent CO2 & Regulator packages, with a periodic refill service provided to site.

Plumbing Licences: WA PL10956, QLD 15089576, NSW 392108C, SA PGE5081

Billi Pre-Filter Range - External Accessory

-  Provides additional filtration support while protecting your under-bench system investment.
-  Suitable for standalone use as an inline filter solution to cold water supply.
-  Compatible with all Billi mixer taps & many other existing tapware manufacturers.
-  Cost effective solution for mains filtering.
-  Kit provides everything you need for easy setup. Replacement and upgrade filter options can be purchased separately.

Contact our friendly customer service team to discuss your pre-filtration needs or visit our webshop at www.Billi.com.au/billi-shop/ to place your order today.

Billi Premium Filtration vs Standard Filtration

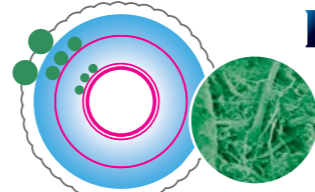

Billi

BWT FIBRON X CARBON FILTER

Fibron X technology uses activated carbon fibre with minimal bonding agent in a graded density profile. Fibron X media has a superior contaminant reduction performance and capacity.

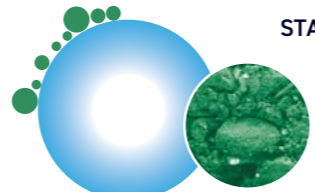

STANDARD

CONVENTIONAL CARBON FILTER

Conventional filters are made up of granules and often held together with a resin, decreasing the surface area and therefore the quality of the filtration.



PRODUCT SUMMARY

Here is a summary of Billi's range of products. Follow these four easy steps to select the Billi instant filtered water system that best suits your needs.

1 Choose your water needs?



2 Please consult page 14 to determine which dispensers are suitable for each water type, and then choose the dispenser that best fits your needs.

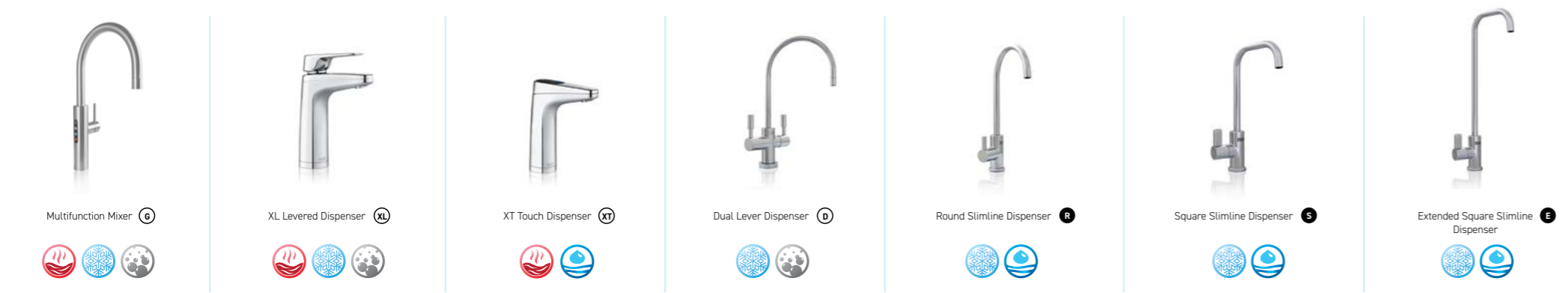

3 If installation over a sink is not an option, you can choose a matching font and/or riser for bench top install.



4 You may like to choose a new standalone mixer tap to complement the style and finish of your chosen dispenser?

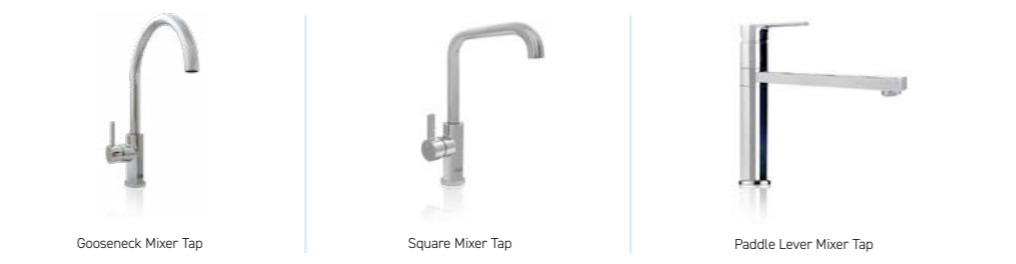

^ dispenser compatibility varies by system type.

Billi's superior instant water systems are a great addition to your family home

Once you've installed one of Billi's Superior Instant Filtered Water systems in your home, you will wonder why you didn't do it sooner. That's because it's so versatile, convenient and above all, provides you with peace of mind.

Picture yourself enjoying a crisp, fresh glass of chilled water then appreciating the convenience of a pot of ready boiled water for food prep, and finally wowing your guests with bottomless sparkling water... all at your fingertips. Follow us online for usage ideas: www.billi.com.au/news/latest-news/billi-sparkling-at-home

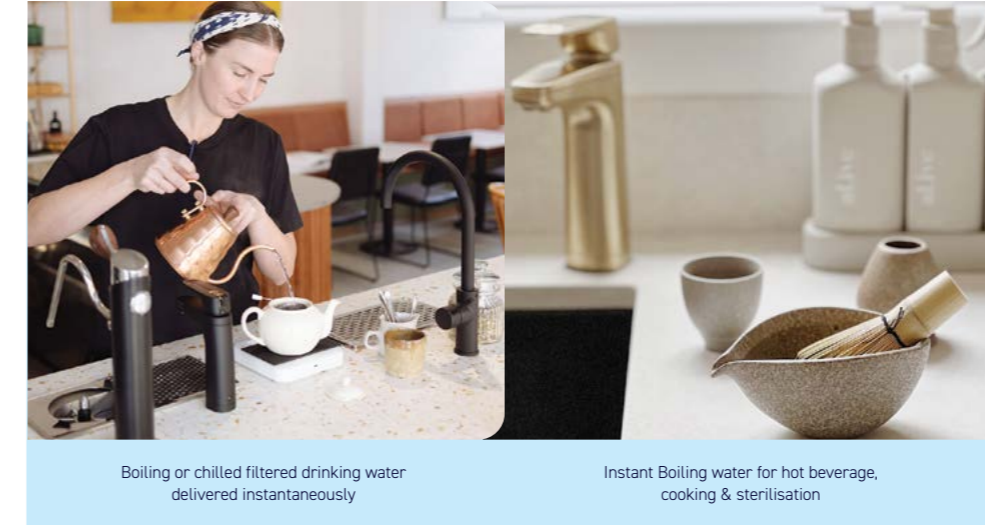

Billi's **3D Build** is the latest mobile innovation. The online tool allows you to specify and shop our products in a few simple clicks.



Build your own filtered water system at: www.billi.com.au/3d-build



flow MEETS FUNCTION

The Billi Multifunction Mixer Tap is a testament to our commitment towards innovation and excellence, we've created a perfect filtered water system that is both functionally versatile and aesthetically elegant for any modern kitchen.

Recognised by Good Design Australia awards, our Multifunction Mixer Tap exemplifies the perfect blend of state-of-the-art filtration with under-bench technology, making it one seamless solution where 'Flow meets Function'.

Multifunction Mixer Tap G

Single fixture that dispenses filtered AND domestic mains supply, replacing dual-fixture installations, (dispenser + mixer tap).

Suits: Billi Home BCS, Billi Home BC, Billi Home BA



- ELEVATED TAP ARCH
- OPTIMISED SPOUT TIP
- SPACE SAVING
- AWARDED BY EXPERTS

- 5 in 1 FUNCTIONALITY
- ERGONOMIC INTERFACE
- SMART SAFETY
- AUSTRALIAN DESIGNED & MADE

All in One Multifunction Mixer Tap. Seamlessly Integrated User Interface.



Urban Brass Multifunction Mixer Tap



Billi Home BCS

The Billi Home BCS system is the ultimate multi-use home water appliance

DISPENSER OPTION FEATURES



Product Code	Model	Power	Suggested Usage
925100	Home BCS	10 amp	<ul style="list-style-type: none"> • Drinking water filtration • Cooking & Food preparation • Instant Hot or Chilled beverages • Sterilisation of baby bottles <ul style="list-style-type: none"> • Cocktails & Mocktails • Herbal teas & specialty beverages • Tempura & cake batters

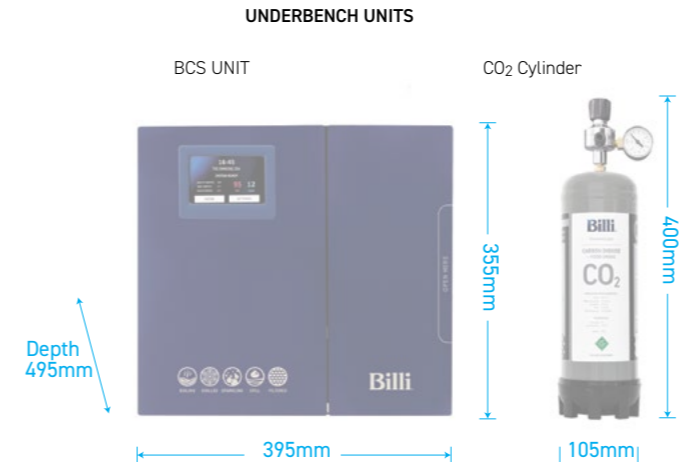

Urban Brass Multifunction Mixer Tap with Home BCS underbench unit

 PRODUCT RANGE



Billi Home BC

Instant boiling and chilled filtered water system

DISPENSER OPTION



FEATURES



Product Code	Model	Power	Suggested Usage
915000	Home BC	10 amp	<ul style="list-style-type: none"> • Drinking water filtration • Cooking & Food preparation • Instant Hot or Chilled beverages • Sterilisation of baby bottles

UNDERBENCH UNIT



Matte Black XL Dispenser



Billi Home BA

Instant boiling and still filtered water system

DISPENSER OPTIONS



FEATURES



Product Code	Model	Power	Suggested Usage
914000	Home BA	10 amp	<ul style="list-style-type: none"> • Drinking water filtration • Cooking & Food preparation • Instant Hot beverages • Sterilisation of baby bottles

UNDERBENCH UNIT





CHILLED

Billi Home C

Chilled filtered water system

DISPENSER OPTIONS



FEATURES



Product Code	Model	Power	Suggested Usage
913000	Home C	10 amp	<ul style="list-style-type: none"> • Drinking water filtration • Cooking & Food preparation • Instant Chilled beverages

UNDERBENCH UNIT



CHILLED



SPARKLING

Billi Home CS

Professional grade chilled & sparkling system

DISPENSER OPTIONS



FEATURES



Product Code	Model	Power	Suggested Usage
913100	Home CS	10 amp	<ul style="list-style-type: none"> • Drinking water filtration • Cooking & Food preparation • Instant Chilled & Sparkling beverages <ul style="list-style-type: none"> • Cocktails & Mocktails • Tempura & cake batters

UNDERBENCH UNITS





Billi Home FT

Instant still filtered water system

DISPENSER OPTIONS



FEATURES



Product Code	Model	Power	Suggested Usage
911000	Home FT	NA	<ul style="list-style-type: none"> • Drinking water filtration • Cooking & Food preparation

UNDERBENCH UNIT



Billi B5000 Sparkling

Instant boiling, chilled, sparkling water system

DISPENSER OPTIONS



FEATURES



Product Code	Model	Power	Suggested Usage
915100	B5000 Sparkling	2 x 10 amps	<ul style="list-style-type: none"> • Drinking water filtration • Cooking & Food preparation • Instant Hot or Chilled beverages • Sterilisation of baby bottles <ul style="list-style-type: none"> • Cocktails & Mocktails • Tempura & cake batters

UNDERBENCH UNITS





Matte Black XL Levered Dispenser

Dispenser finishes

Our dispensers come in a variety of modern and stylist finishes to match your kitchen environment. There are currently 6 finishes in the range* to choose from.

Standard finishes



Special order finishes



*Refer to individual specification for available finish range by product variant



Urban Brass XL Levered Dispenser with complementary Round Mixer Tap 21

X SERIES DISPENSERS



XL Levered Dispenser **(XL)**

The levered dispenser is streamlined and elegant. It is simply operated with position-sensitive levers.

Suits Billi Home BC, Billi Home BCS, Billi Home BA

AVAILABLE FINISHES

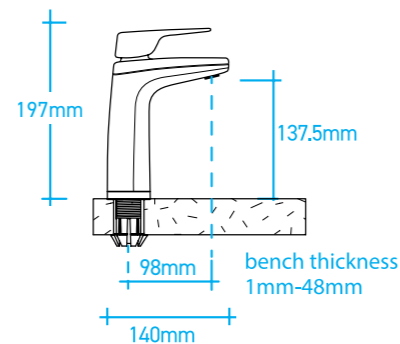

XT Touch Dispenser **(XT)**

The touch dispenser is an innovative, contemporary design, which has a top operating panel offering a sophisticated and clean style.

Suits Billi Home BA

AVAILABLE FINISHES

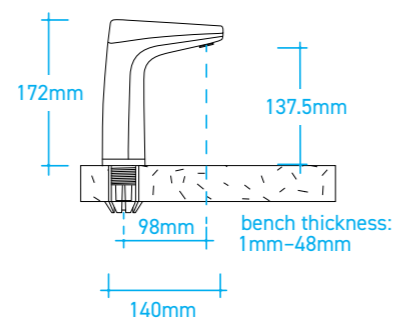
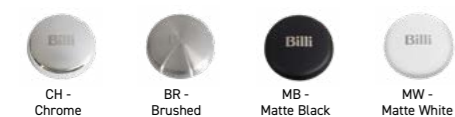

Matte Black XL Levered Dispenser with matching 120mm riser and font

SLIMLINE DISPENSERS



Round Slimline Dispenser **(R)**

Round in design with single pin lever option. Suitable for ambient or chilled water.

Suits Billi Home C, Billi Home FT

AVAILABLE FINISHES

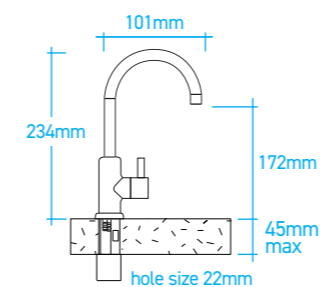

Square Slimline Dispenser **(S)**

Square in design with single paddle lever option. Suitable for ambient or chilled water.

Suits Billi Home C, Billi Home FT

AVAILABLE FINISHES

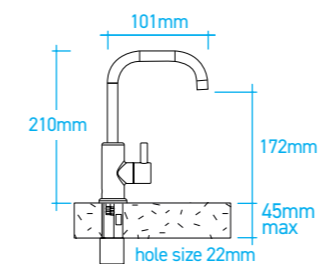

Extended Spout Square Slimline **(E)**

Extended spout allows bottles and jugs to be filled when the tap is installed on a font.

Suits Billi Home C, Billi Home FT
Add finish code to the product code (991900SCH / 991900SBR / 991900SMB)

AVAILABLE FINISHES

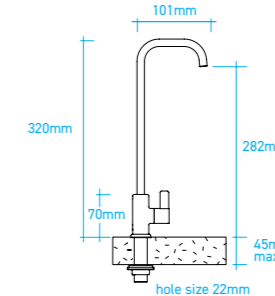
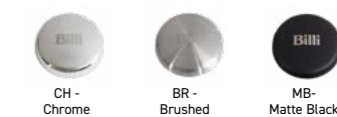

Dual Lever Dispenser **(D)**

Round in design with dual levers. Suitable for chilled and sparkling water.

Suits Billi Home C

AVAILABLE FINISHES

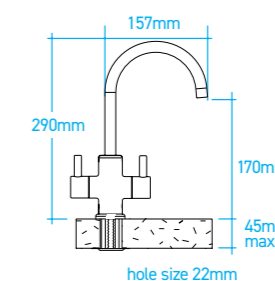
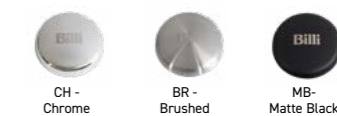

Multifunction Mixer Tap **G**

Single fixture that dispenses filtered AND domestic mains supply, replacing dual-fixture installations, (dispenser + mixer tap).

Suits Billi Home BCS, Billi Home BC, Billi Home BA, Billi B5000 Sparkling

AVAILABLE FINISHES

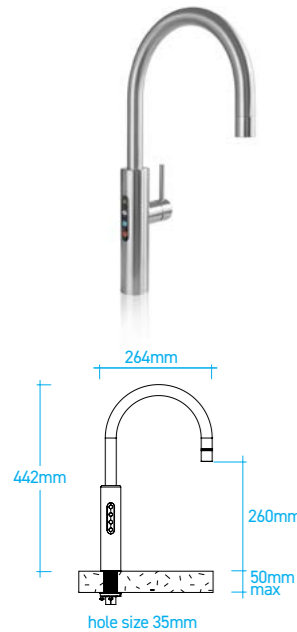

Gooseneck Mixer Tap **G**

Round gooseneck design as a complementary standalone mixer tap. Requires hot and cold mains connection.

Add finish code to the product code (991600GCH)

AVAILABLE FINISHES



Paddle Lever Mixer Tap **P**

Paddle lever design as a complementary standalone mixer tap. Requires hot and cold mains connection.

Add finish code to the product code (991800PCH)

AVAILABLE FINISHES

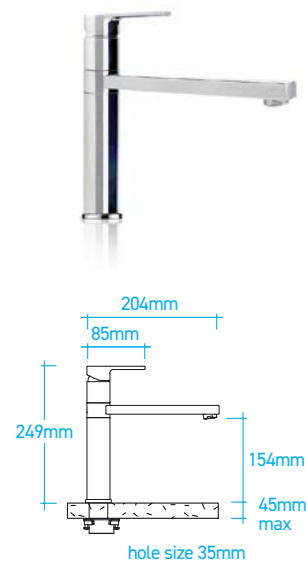

Square Mixer Tap **S**

Square gooseneck design as a complementary standalone mixer tap. Requires hot and cold mains connection.

Add finish code to the product code (991700SCH)

AVAILABLE FINISHES

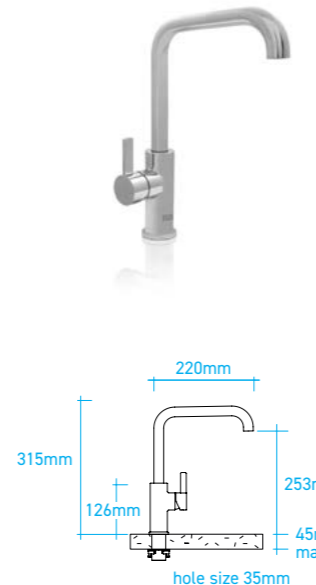

Fonts and Risers

Font and Risers are needed for benchtop installations when it's not an option for your Billi dispenser to sit over a sink. Perfect for home offices located outside of the main dwelling, butlers pantries or outdoor kitchens.



992800 - 70mm FONT & RISER
Suitable for XL levered & XT Touch dispensers



992803 - 120mm FONT & RISER
Suitable for XL levered & XT Touch dispensers



992810 - SLIMLINE FONT
Suitable for slimline dispensers

AVAILABLE FINISHES

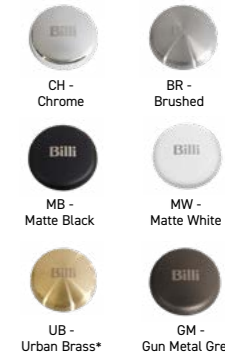

* Special Order Finishes

CO₂ Cylinders

CO₂ Cylinder replacements are available in single or 2 pack (1.1kg each) for all Billi underbench Sparkling units:

For support, service or to purchase filters and CO₂, scan this code



996911 - CO2 Cylinder - Single (1.1kg)
Suitable for all Billi Sparkling models



996912 - CO2 Cylinder - 2 pack (2 x 1.1kg)
Suitable for all Billi Sparkling models



Refillable CO₂ Filter Plan

Billi now offers customers an environmentally friendly option to rent CO₂ and Regulator packages, with a periodic refill performed at your site with any regularity from weekly to annually (depending on your usage).

* Selected areas only.

Replacement Filters

3 x Replacement filters are available for different environments:



994052 - 0.2 Micron Fibron XC® Replacement Filter
Highest level of filtration for optimal drinking water quality



994051 - 5 Micron Fibron X® Replacement Filter
Standard premium filtration for all environments



994054 - HSD Fibron XT® Replacement Filter
Ideal for High Sediment areas to ensure premium filtration without compromising on water flow

Billi Filters are available online at www.Billi.com.au/products/filters/ for purchase

WHY OUR CUSTOMERS LOVE THEIR BILLI

Regina, Vic

"The Billi hot & filtered cold tap is by far the more superior product in my experience. There are 4 reasons for this. Firstly, we love the ease with which the Filter Cartridges - just slot in and click into place for replacement, couldn't be simpler. The second major advantage is the reduced and more efficient unit size that sits underneath in the cabinet below - it takes up far less room than the competitor offering. Importantly, the price point is by far lower, a real no brainer! And lastly, the unit is reliable and looks fabulous. I could not recommend the Billi tap enough. It isn't my first Billi tap, and it won't be my last!"

Marteli, NZ

"I would like to add a thank you to your technician; he was very clear in his explanation and made it easy for me to understand. He carried out many tests that no one had done before, and it's refreshing to get to the bottom of my issue. While I understand it is an ongoing problem due to the plumbing works, the technician provided me with quick fixes in the meantime. Enjoy your afternoon!"

Google Reviews **Sugi Tjiu, Melbourne**

"Extremely happy with the purchase and service by Billi team. I have installed the unit for more than a year without hiccup. The convenience of using the product makes me smile every time I use it. Glad to be able to support our local Australian manufacturing that is now a rare sight. Keep up the good work!"

Fotis, Melbourne

"Such a convenient and good looking appliance. There isn't a day that goes by where we don't use our Billi. Easily pour boiling, chilled or sparkling filtered water at the touch of a button. This is our 2nd one, we moved into a house that didn't have a Billi and had to put one in!"

@scotbuildshamptonshome

Best investment ever... I love how quick I can make my coffee/tea in the morning with this instantaneous hot water Billi tap #billitap #instantaneous #instanhotdrinks #tea #coffeeover #coffee @billiwater



Urban Brass XL Levered Dispenser



XI Levered Dispenser in Matte white with matching 70mm Riser and Font.

Billi® is a registered trademark of Billi Australia Pty Ltd. All rights reserved. © Copyright protected. As Billi Australia Pty Ltd has a policy of continual improvement, all details are subject to change without notice. All goods are sold subject to our published terms and conditions. 0325

Billi®



home



Billi Australia Pty Ltd

P 1800 812 321
F +61 3 9469 0499
W www.billi.com.au

Billi New Zealand Ltd

P 0800 636 0 636
F +64 9 636 8636
W www.billi.co.nz



 Designed and manufactured in Australia



Urban Brass Multifunction Mixer Tap